



Kifaru Siwash & Late Season Handbook

Pack Anatomy..... 1-3
 Removing the Waist belt..... 4
 Installing Pockets..... 5-6
 Add a CargoChair..... 7-8
 Add a GunBearer 9-10
 Glossary back cover
 Fitting Instructions..... sewn into your pack Chamber

all information is copyright 2008, Kifaru International
 KIFARU, INTERNATIONAL • www.kifaru.net • 1-800-222-6139

FRONT ANATOMY & POCKET PLACEMENT SIWASH

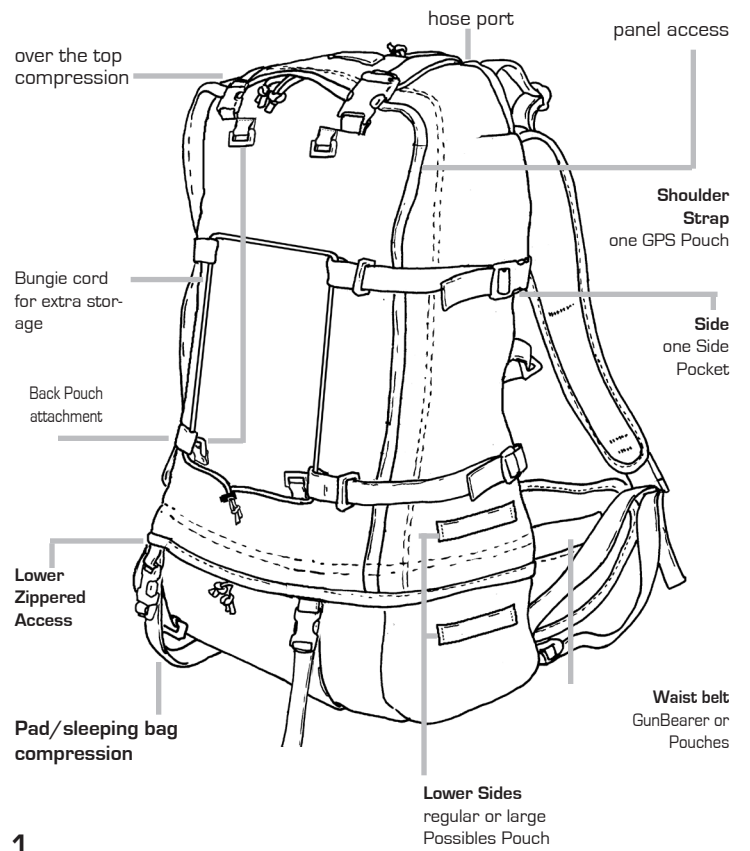

1.

FRONT ANATOMY & POCKET PLACEMENT LATE SEASON



2.

ANATOMY OF THE BACK may vary slightly by model

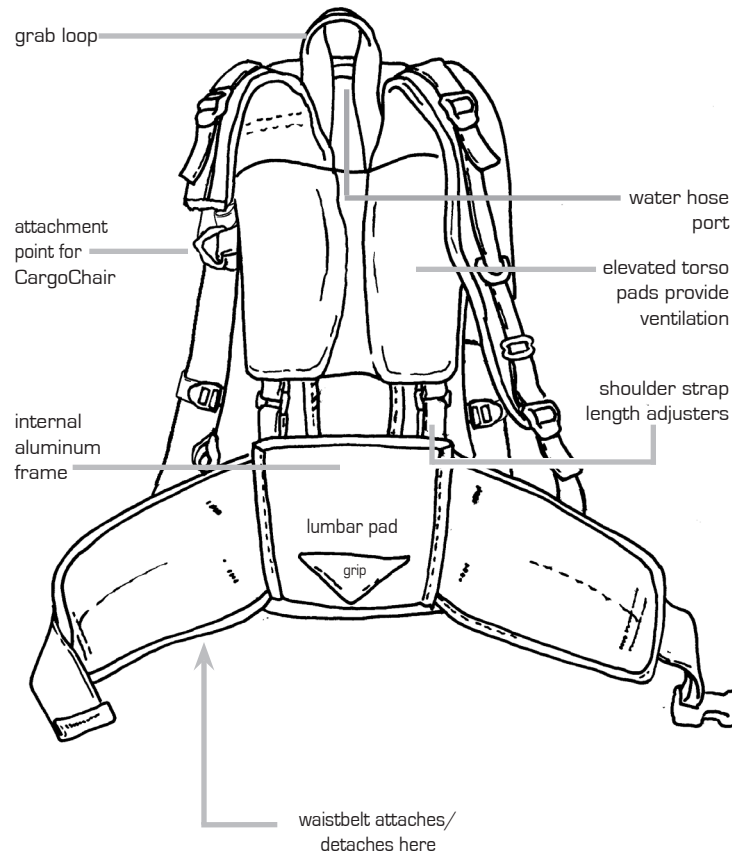

3.

REMOVING THE WAISTBELT

Your waistbelt can be removed entirely for easier airline travel.

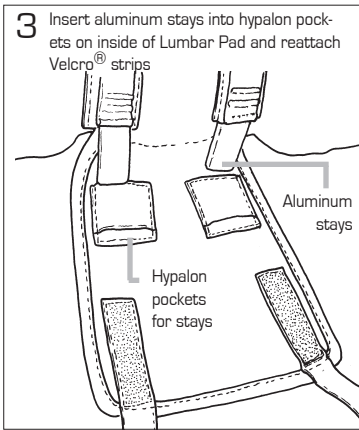
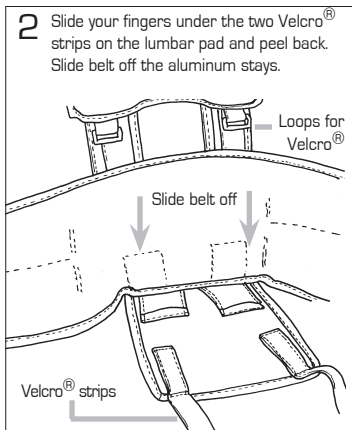
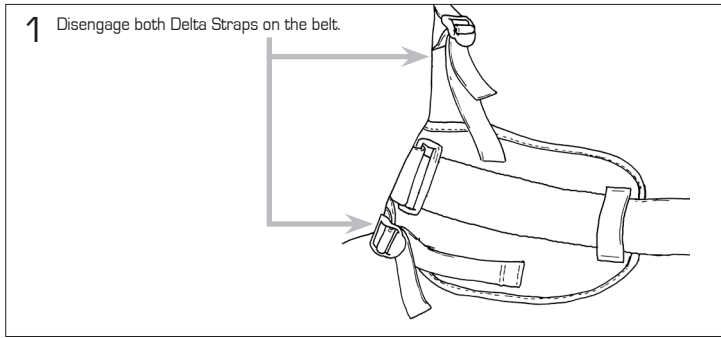

4.

INSTALLING SIDE POCKETS OR A BACK POUCH

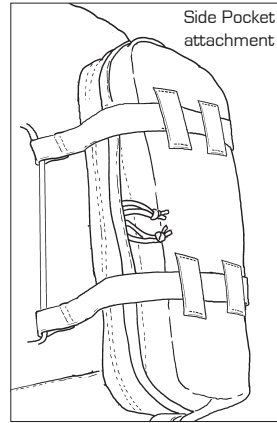

Side Pockets

Thread the pack compression straps OVER the "back" of the Pocket (through anchor points) for best stability, and compress.

Back Pouch

Attach the Back Pouch top and bottom via common loops on the pack body. Compress this Pouch by snug-ging the bungee over it. Can be installed with either camo or Int'l. Orange facing out.

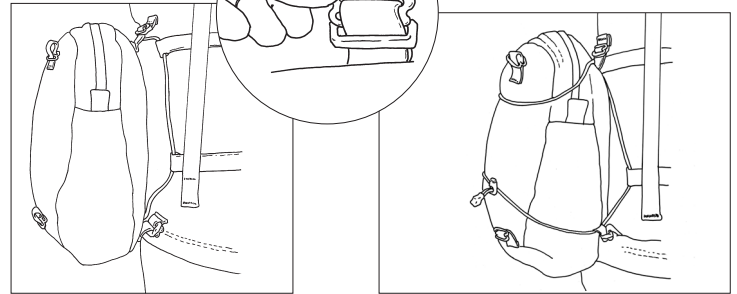

5. top and bottom attachment points

compress with the pack's bungee

INSTALLING POCKETS

The Chamber

The inside top portion of your pack comes with a Chamber for your valuables. You may remove this and take it with you by sliding the 3 bars back through the common loops.

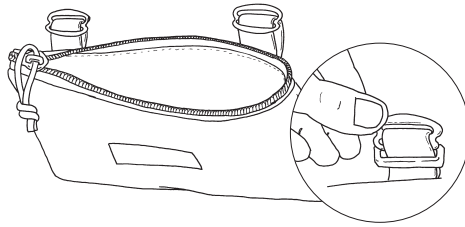

PullOuts

Add PullOuts to your pack by running a Snap Clip clip through any loop of webbing on the pack and the PullOut tab loop.

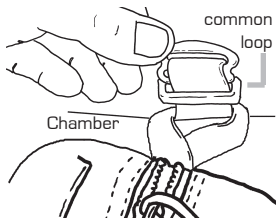
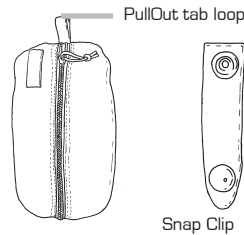

In conjunction with a Chamber (inside pack body): remove Chamber and thread the top loop of the PullOut through the metal 3 bar (on Chamber). Reinsert 3 bar back into Common Loop of your pack.

Possibles Pouch

Available in regular or large size, and can affix in two places.

the waistbelt opposite your GunBearer

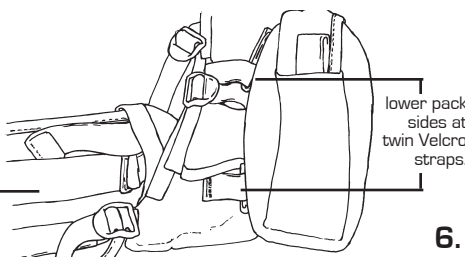

6.

ADDING A CARGOCHAIR™ pat. pend

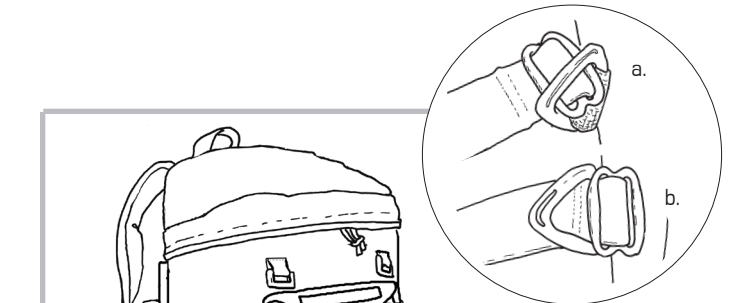

1. Upper Attachments

Each side of your pack has a triangle loop. Thread the 3-bar through it.

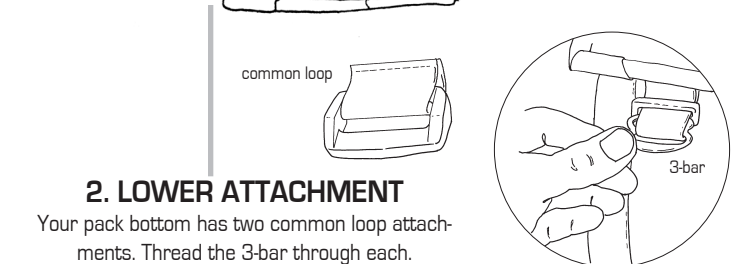

2. LOWER ATTACHMENT

Your pack bottom has two common loop attachments. Thread the 3-bar through each.

7.

CARGOCHAIR™ as a Chair pat. pend

With the CargoChair attached, lengthen the straps fully at the ladderlock buckles. Flip the platform 180° so it extends under the pack back. Take a seat, adjust for comfort. You now have a comfortable, back supporting seat - great for long sessions of glassing or resting by the campfire.

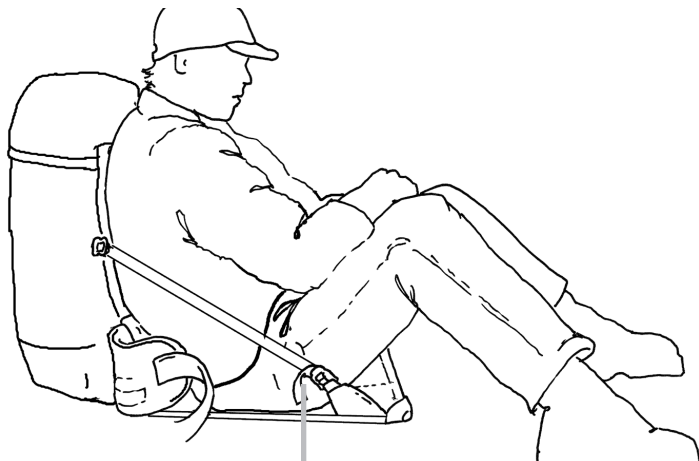

Adjust for comfort here with Ladderlock buckle

CargoChair Storage

Just snug up the straps and the CargoChair will ride flush against the pack body, or remove it and store in the pack.

8.

THE GUNBEARER®

Haul your long gun with the weight on your hips, not your shoulders, yet level it for firing in a split second. Leaves your hands free for other work. Included with your pack.

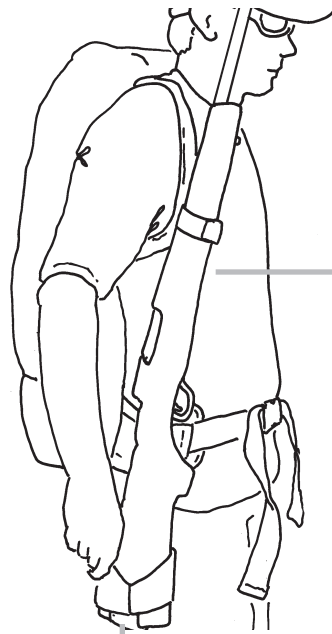

The weight of your firearm rests comfortably on your hips

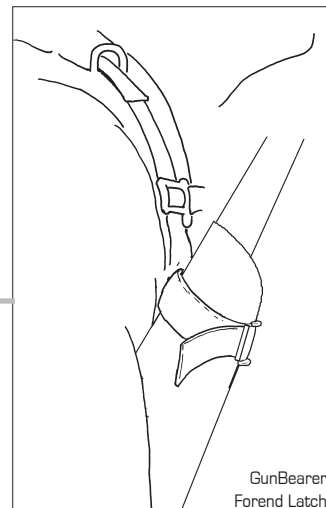

GunBearer Forend Latch

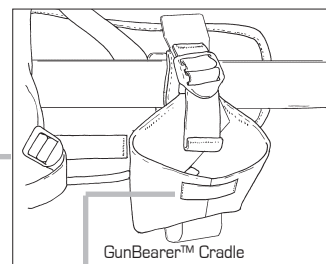

GunBearer™ Cradle

Affix optional Cartridge Pouch here

9.

INSTALLING THE CRADLE

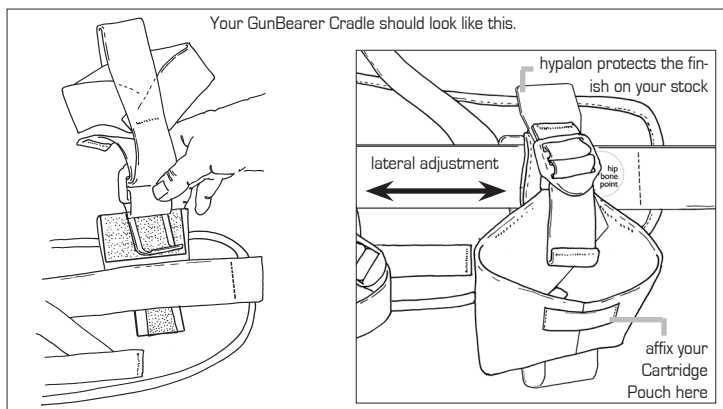

Place the firearm in the Cradle, and wrap the Upper GunBearer strap around the forend, push down on the Camlock until you feel it click (camlock should be on the **bottom** of your forend. Your firearm is now securely in place.

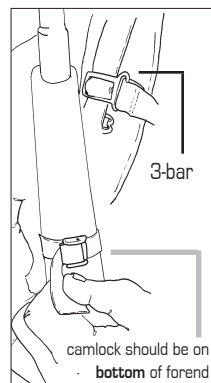

Using the GunBearer: with the hand opposite the GunBearer, reach across and pull sharply outward on the end of the strap to pop the camlock open. Pull firearm out of the Cradle and level.

Fine Tuning: If the barrel is too near your face, try the following:

1. **Make sure Sternum Strap is not too tight.**
2. Lower 3 bar on shoulder strap if the barrel is too close to your face - the tilt should be about a 20 - 30° angle.
3. Move Cradle forward or backwards to change the angle of the weapon. It should be slightly behind your pant center line.
4. Make sure the long gun is installed such that you can close the forend buckle on the **bottom** of the forend

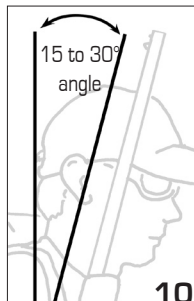

10.

PACK PARTS

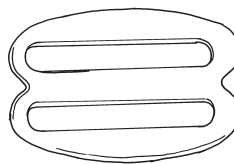

Metal 3 Bar

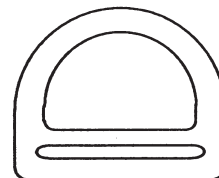

D-ring

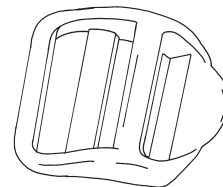

Ladder lock

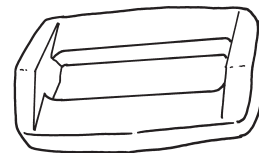

Common loop

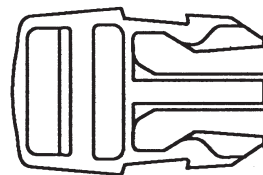

Side Release (SR) Buckle, male

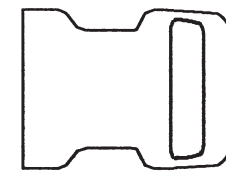

Side Release (SR) Buckle, female